

# Liquid Freezer III 280 A-RGB

Multi Compatible All-in-One CPU Water Cooler with A-RGB



## General Specifications

Compatibility	Intel® LGA1851, LGA1700   AMD® AM5, AM4
PI   NNPI	319   259
TIM	MX-6 (0.8g)
Warranty	6 Years
Operating Ambient Temperature	0-40°C
Weight	1765 g
LED-Connector	3-Pin A-RGB Connector

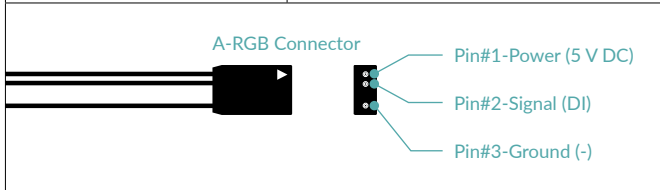

All-In-One Connector	4-Pin PWM Connector
----------------------	---------------------

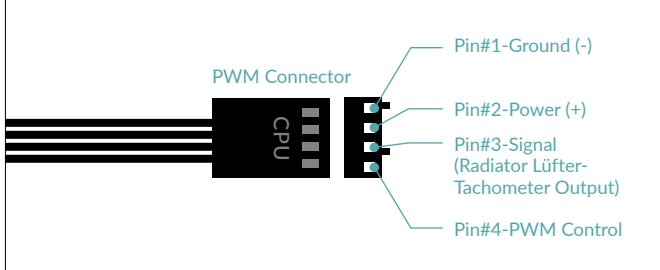

Split Connector	3x 4-Pin PWM Connector
-----------------	------------------------

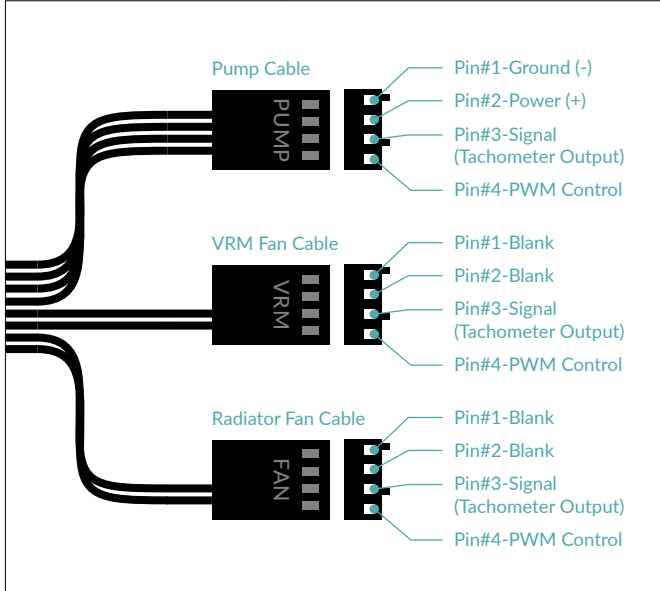

Pump	800-2800rpm (PWM controlled)
Current   Voltage	0.35 A   12 VDC
Cold Plate	Copper, Micro Skived Fins
Tube Length	450mm
Tube Diameter	Outer: 12.4 mm   Inner: 6.0mm
<b>Radiator</b>	
Material	Aluminium
Dimensions	317 (L) x 138 (W) x 38 (H) mm
<b>VRM Modul</b>	
VRM Fan	400-2500rpm (PWM controlled)
Current   Voltage	0.05 A   12 VDC
LEDs	12x A-RGB LEDs
Current   Voltage	0.40 A   5VDC

## Radiator Fan Specifications

General	2x P14 PWM A-RGB
Speed	200-1900rpm
Airflow	69.90 cfm   117.06 m³/h
Static Pressure	2.0mmH <sub>2</sub> O
Bearing	Fluid Dynamic Bearing
Current   Voltage	0.17 A   12 VDC
Cable Length	40 mm
Connector	4-Pin PWM Connector
<b>RGB Specifications</b>	
LEDs	12x A-RGB LEDs
Current   Voltage	0.40 A   5VDC
Cable Length	40 mm + 80mm Splitter Cable
Connector	3-Pin A-RGB Connector + 3-Pin Plug

## Shipping Information - LF III 280 A-RGB (Black)

Box Dimension	335 (L) x 170 (W) x 155 (H) mm
Gross Weight	2300 g
SKU	ACFRE00143A
EAN	4895213704519
UPC	840033402286

## Shipping Information - LF III 280 A-RGB (White)

Box Dimension	335 (L) x 170 (W) x 155 (H) mm
Gross Weight	2300 g
SKU	ACFRE00151A
EAN	4895213704557
UPC	840033402323

# Liquid Freezer III 280 A-RGB

Multi Compatible All-in-One CPU Water Cooler with A-RGB

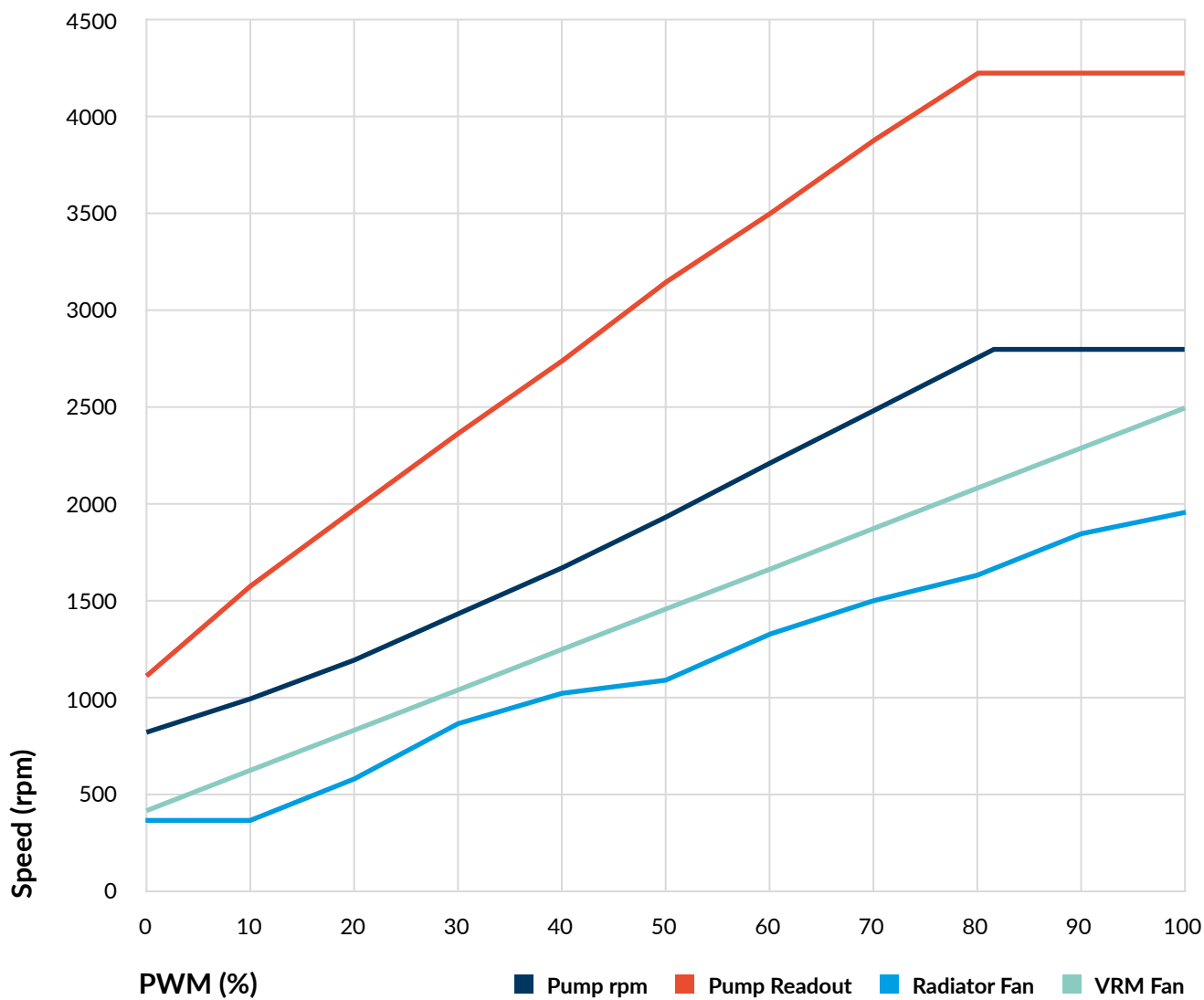

# Liquid Freezer III 280 A-RGB

Multi Compatible All-in-One CPU Water Cooler with A-RGB

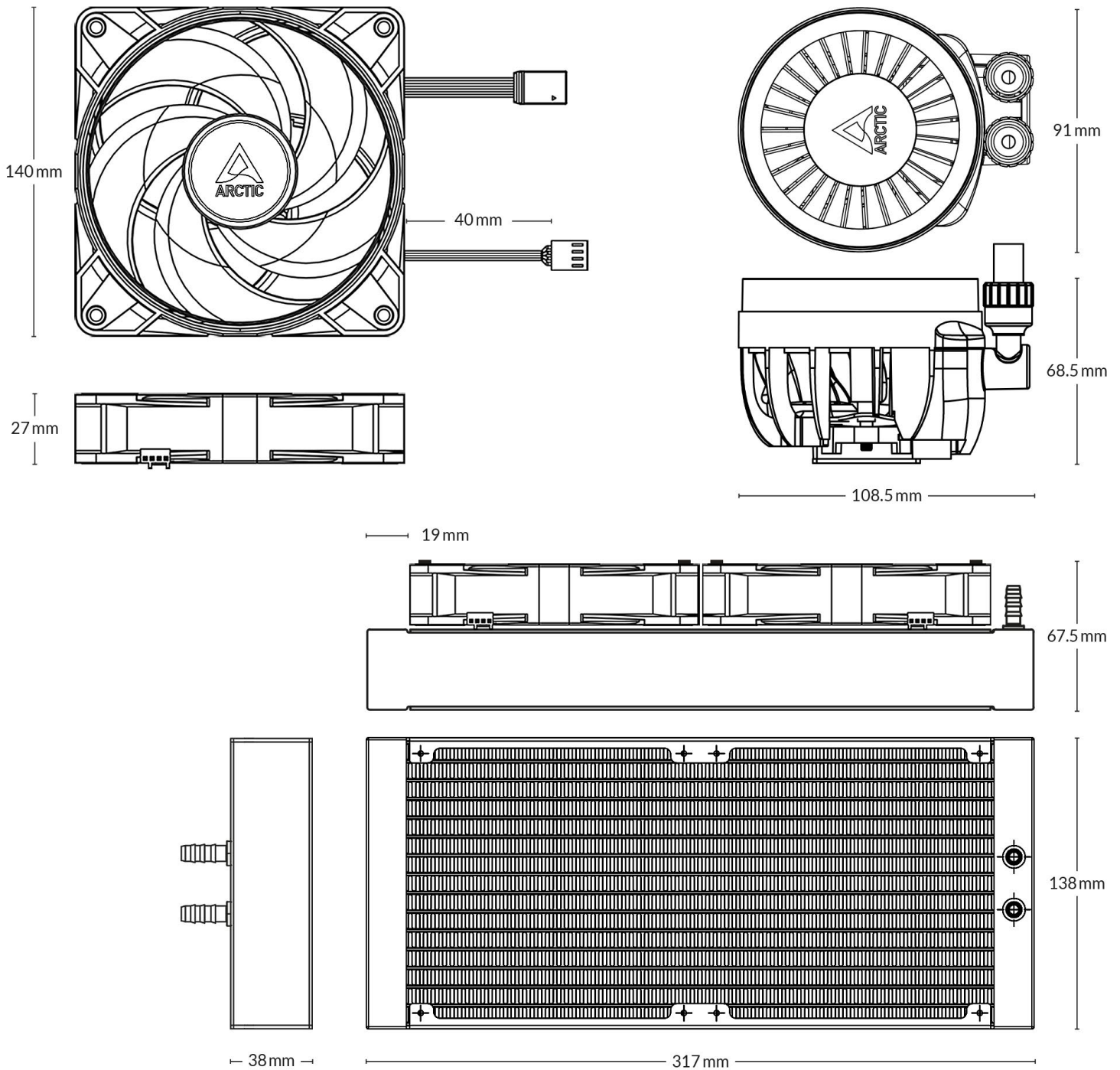

All materials are compatible with RoHS requirements.

MORE INFORMATION



MANUALS

